

ULTRADYN™ FB02-FC-FUS0353

Ultrafiltration Modules

High mechanical strength, backwashable membrane in a wide range of membrane types make ULTRADYN™ hollow fiber modules suitable for all applications requiring a high level of purification and high packing density. ULTRADYN modules are available with polyethersulfone (PES), polyacrylonitrile (PAN) and cellulose tri-acetate (CTA) hollow fiber membrane types and in configurations that can be sterilized with hot water up to 98 °C, eliminating bacterial growth and preventing fouling.

ULTRADYN modules are available with a hollow fiber inner diameter range from 0.5 to 1.4 mm, and module size range from 0.1 m² to 17 m². ULTRADYN hollow fiber modules have proven particularly successful in applications such as wine filtration, pure water filtration, pharmaceuticals, electronics, and surface water treatment.

MEMBRANE CHARACTERISTICS

Membrane Chemistry	Polyethersulfone (PES)
Molecular Weight Cut-Off	30,000 Dalton
Hollow Fiber Inner Diameter	0.5 mm

PHYSICAL DIMENSIONS

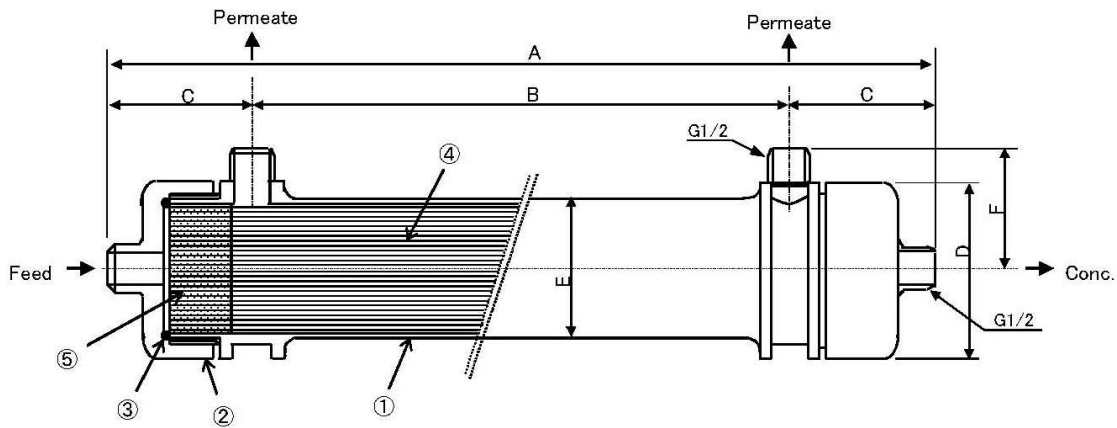

	A	B	C	D	E	F
Dimension - mm	356	250	53	Ø 60	Ø 45	42

Item	Description	Material	Quantity
1	Hollow Fiber	Polyethersulfone	-
2	Cap	Polysulfone	2
3	Case	Polysulfone	1
4	O-Ring type AS568-239	Fluoro-rubber (FPM)	2
-	Potting Resin	Epoxy Resin	-

OPERATING PARAMETERS & MODULE SPECIFICATIONS

Membrane Area	0.4 m ² (4.3 ft ²)
Standard Water Flux^a	300 l/h (1.32 gpm)
Shipping Water Flux^a	220 l/h (0.96 gpm)
Maximum Feed Inlet Pressure^b	4 bar (58 psi)
Maximum Transmembrane Pressure	3 bar (44 psi)
Maximum Temperature	98°C (208°F)
Applicable pH range	1 - 13
Standard Inlet Feed Flow^c	710 l/h (3.12 gpm)
Operating Weight	0.9 kg (1.98 lb)
Shipping Weight	0.4 kg (0.88 lb)
Standard Preservative	Pure water (heat sterilized)
Feed/Conc. Connectors	G1/2
Permeate Connectors	G1/2

a Initial water flux by dead end filtration with pure water under TMP 0.1 MPa at 25°C.

b Standard condition is adjusted to 1 m/sec feed velocity. The optimum velocity is different for each application.

c This value is applicable at 25°C.

d Maximum pressures depend on operating temperature. See instruction manual for further information.

* DAICEN Membrane Systems Ltd. is the manufacturer of the ULTRADYN modules and markets and distributes them under the registered trademark MOLSEP®.

CUSTOMIZABLE SPECIALTY ELEMENTS

MANN+HUMMEL Water & Fluid Solutions offers a full range of membranes and element designs for challenging water and process applications. Technologies include low-fouling RO, submerged UF, continuous high temperature, ultra-high pressure, unique sanitary designs and more. Contact us to customize a product that satisfies your specific requirements.

Contact

Europe

Germany: +49 611 962 6001
 Italy: +39 0721 1796201
 info@microdyn-nadir.com

Americas

USA: +1 805 964 8003
 sales.mnus@microdyn-nadir.com

Asia

Singapore: +65 6457 7533
 China: +86 10 8413 9860
 waterchina@mann-hummel.com